

Technical data sheet



Product features

Electric fryer 2 baskets 0,42 kW/l, 5+5 l counter top 230 V

Model	SAP Code	00000901
--------------	-----------------	----------



- Basin volume [l]: 5
- Drain: No
- Maximum device temperature [°C]: 190
- Minimum device temperature [°C]: 50
- Material: Stainless steel
- Heating location: Inside the tank
- Ignition: Electric
- Number of baskets: 2
- Basket size [mm]: 130 x 235 x 100

SAP Code	00000901	Power electric [kW]	4.200
Net Width [mm]	398	Loading	230 V / 1N - 50 Hz
Net Depth [mm]	0	Basin volume [l]	5
Net Height [mm]	311	Number of baskets	2
Net Weight [kg]	10.00	Basket size [mm]	130 x 235 x 100

Technical data sheet



Technical drawing

Electric fryer 2 baskets 0,42 kW/l, 5+5 l counter top 230 V

Model

SAP Code

00000901

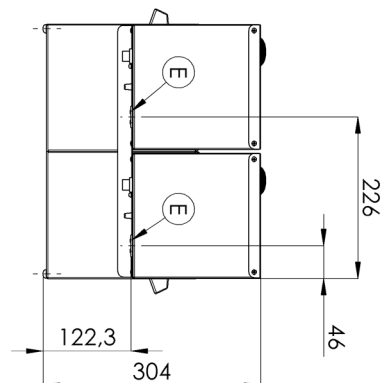
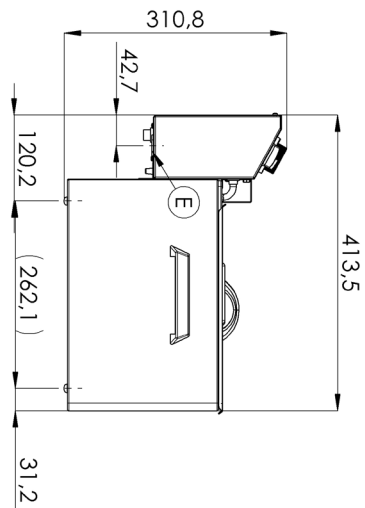
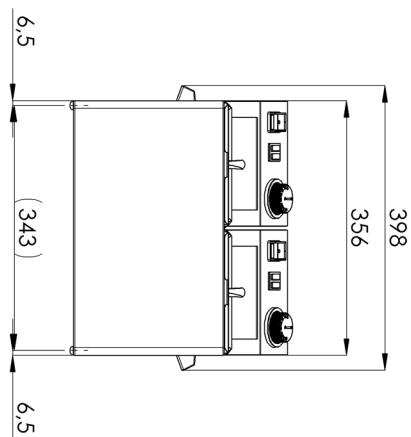

Electric fryer 2 baskets 0,42 kW/l, 5+5 l counter top 230 V

Model

SAP Code

0000901

1

All-stainless design

long life
resistance of AISI 304 stainless steel material
the material does not cut

- savings on service interventions
- easier and faster operation

2

Degree of protection of the control elements IPX4

maintenance-free system
resistance to splash water
long life

- savings on service interventions
- easy cleaning and maintenance of equipment

3

Effective cold zone

prevents food residues from burning
there is no change in the taste of the oil

- longer oil life
- easy access and maintenance

4

Removable heating element

longer lifetime
easy access

- fully removable electric box with heating element for convenient cleaning and servicing
- easy access even to corners and time saving

5

Removable container

stainless steel container with handles

- easier cleaning and handling
- dishwasher safe

6

Manipulation

easy portability

- flexibility in the kitchen, can be used for banquets

7

Prevention of spontaneous combustion

higher rear chimney

- safer heat dissipation and separation of oil and ventilation from the fryer

8

2 thermostats

safety and working thermostat

- traffic safety
- prevention of spontaneous combustion
- Prevention of oil flashover

Technical data sheet



Technical parameters

Electric fryer 2 baskets 0,42 kW/l, 5+5 l counter top 230 V

Model

SAP Code

00000901

1. SAP Code:

00000901

2. Net Width [mm]:

398

3. Net Depth [mm]:

0

4. Net Height [mm]:

311

5. Net Weight [kg]:

10.00

6. Gross Width [mm]:

400

7. Gross depth [mm]:

450

8. Gross Height [mm]:

330

9. Gross Weight [kg]:

11.50

10. Device type:

Electric unit

11. Construction type of device:

Table top

12. Power electric [kW]:

4.200

13. Loading:

230 V / 1N - 50 Hz

14. Ignition:

Electric

15. Protection of controls:

IPX4

16. Material:

Stainless steel

17. Indicators:

operation and warm-up

18. Worktop material:

AISI 304

19. Worktop Thickness [mm]:

0.80

20. Standard equipment for device:

lid and basket

21. Basin volume [l]:

5

22. Maximum device temperature [°C]:

190

23. Minimum device temperature [°C]:

50

24. Safety thermostat up to x ° C:

235

25. Adjustable feet:

Yes

26. Heating element material:

AISI 304

27. Number of baskets:

2

28. Basket size [mm]:

130 x 235 x 100

Technical data sheet



Technical parameters

Electric fryer 2 baskets 0,42 kW/l, 5+5 l counter top 230 V

Model	SAP Code	00000901
--------------	-----------------	----------

29. Heating element construction:

Large surface area coiled heating element to extend its life and heat the oil bath evenly

31. Heating location:

Inside the tank

30. Drain:

No